

Varenummer: 01020371
 Beskrivelse: Seeger låsering J 20 DIN 472
 Rustfast 411

Mål

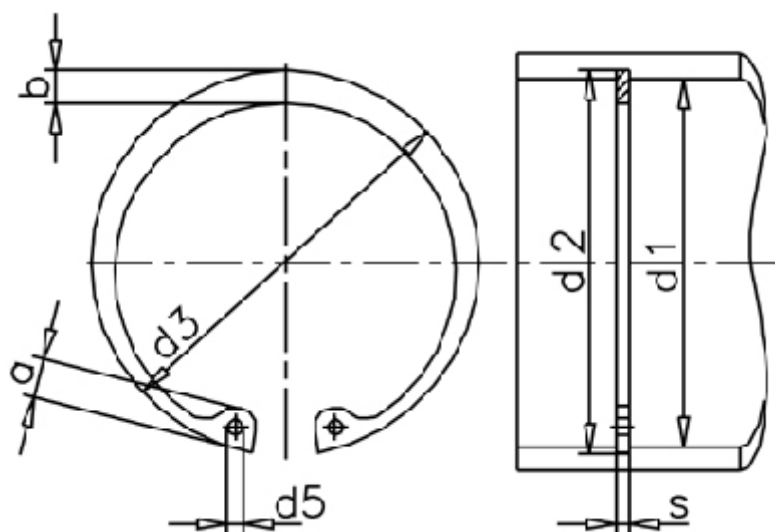

a max	= 4,1	FN kN	= 5.40	t	= 0.50
AN mm ²	= 32.2	FRg kN	= 2.6	Tang	= ZGJ-2
b	= 2.3	FR kN	= 7.2	tol	= -0.06
Betegnelse	= J 20	g	= 1.0	tol	= +0,42-0,13
d1	= 20	K kN-mm	= 16.9	tol	= +0,13
d2	= 21.0	m min	= 1.10	vægt kg/1000	= 0.90
d3	= 21.50	Nominel træk	= 1.5		
d5 min	= 2.0	s	= 1.00		